

Let's Sort it!

2D Shape and 3D Object Sorting Game

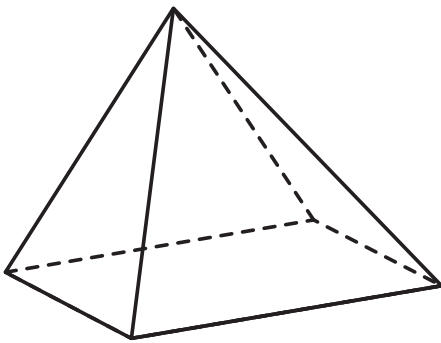

square
based
prism

pentagon

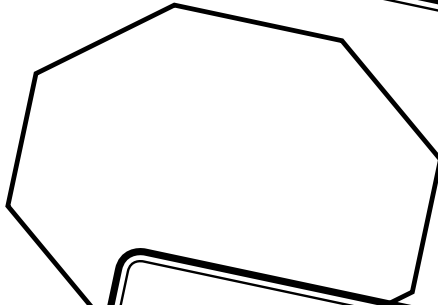

triangular
prism

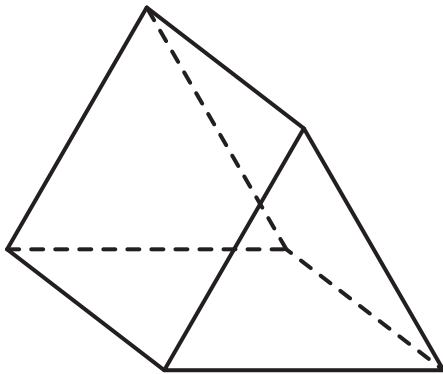

Let's Sort it!

2D Shape and 3D Object Sorting Game

CARDS

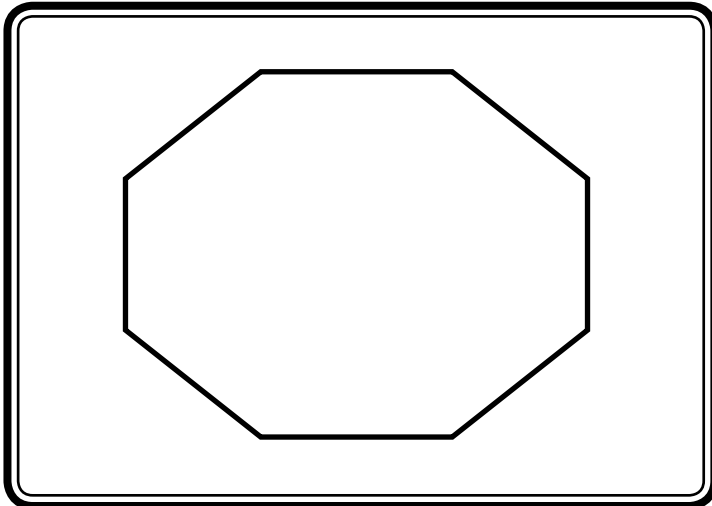
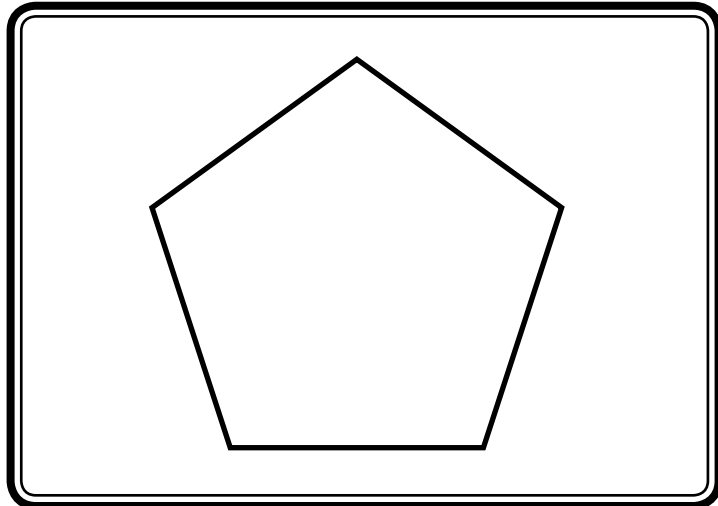
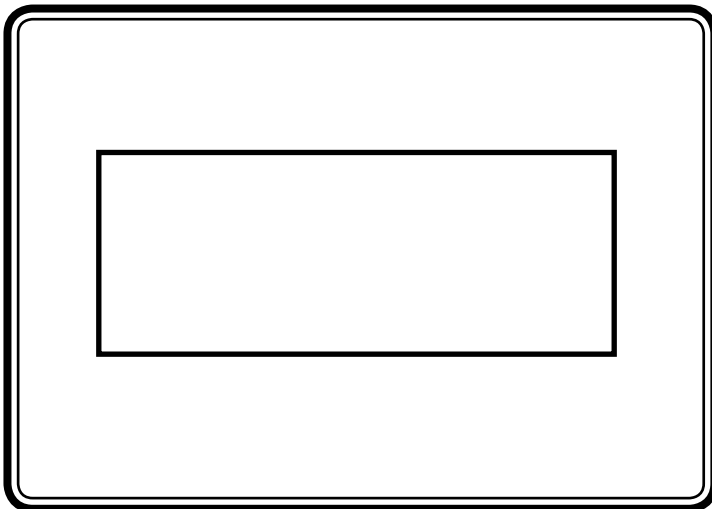
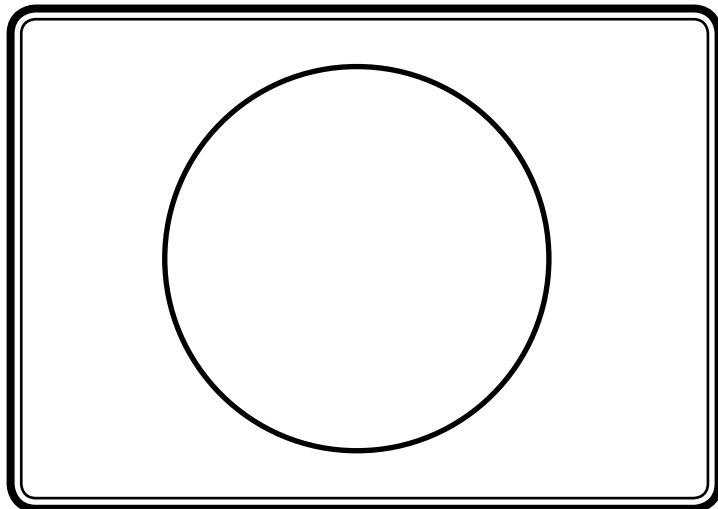
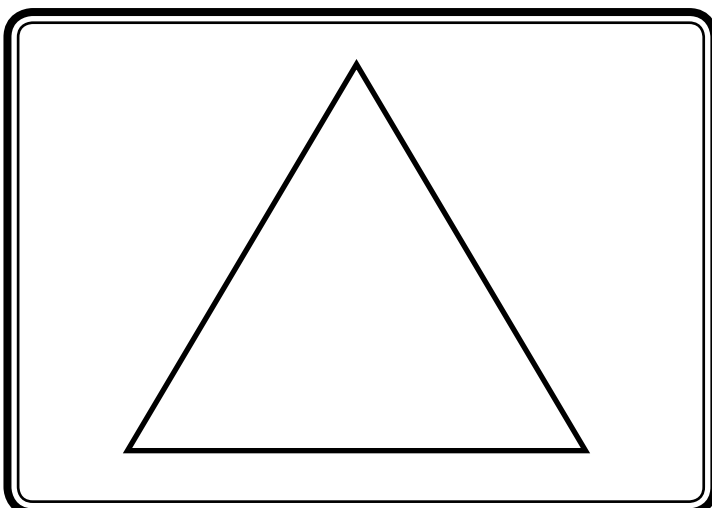
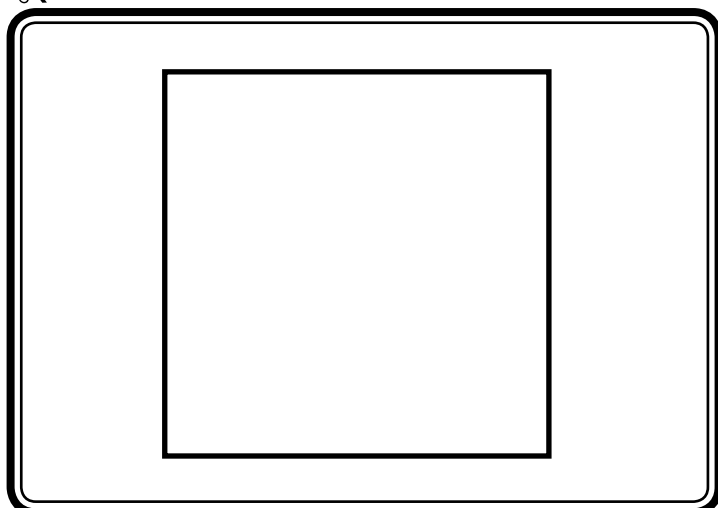

Let's Sort it!

2D Shape and 3D Object Sorting Game

CARDS



square

triangle

circle

rectangle

pentagon

octagon

Let's Sort it!

2D Shape and 3D Object Sorting Game

CARDS

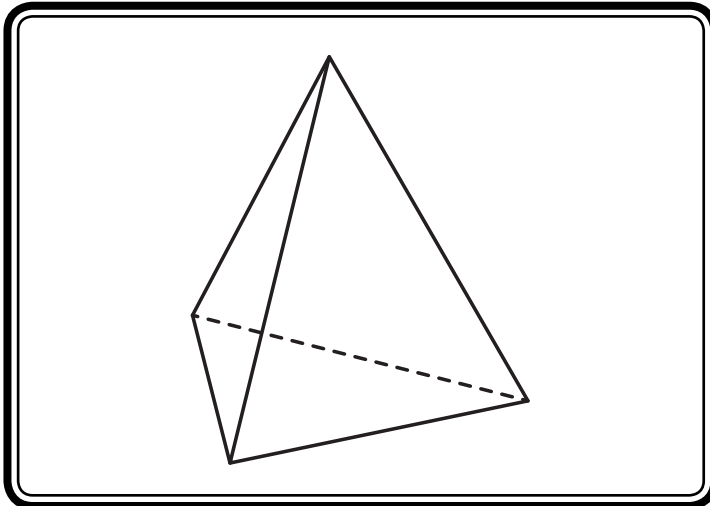
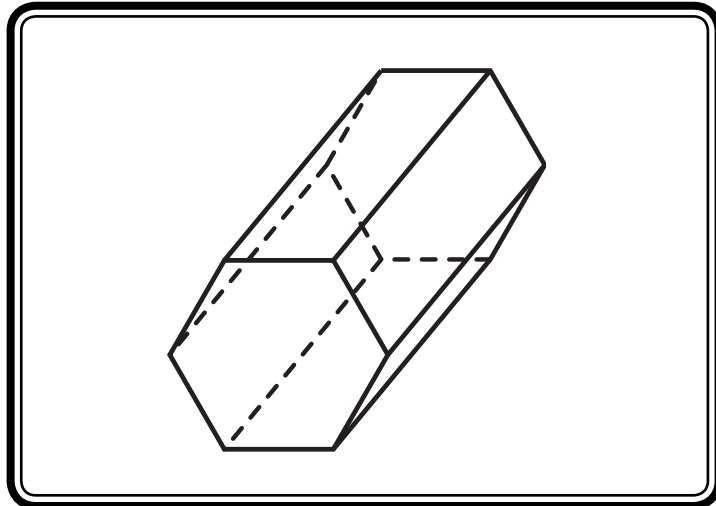
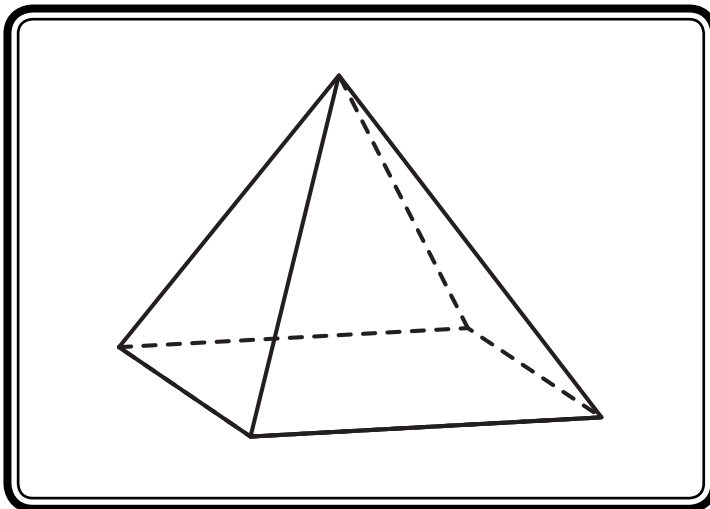
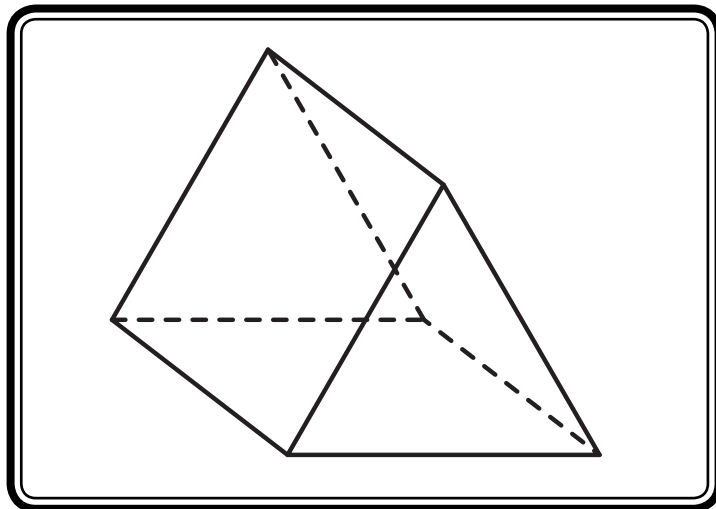
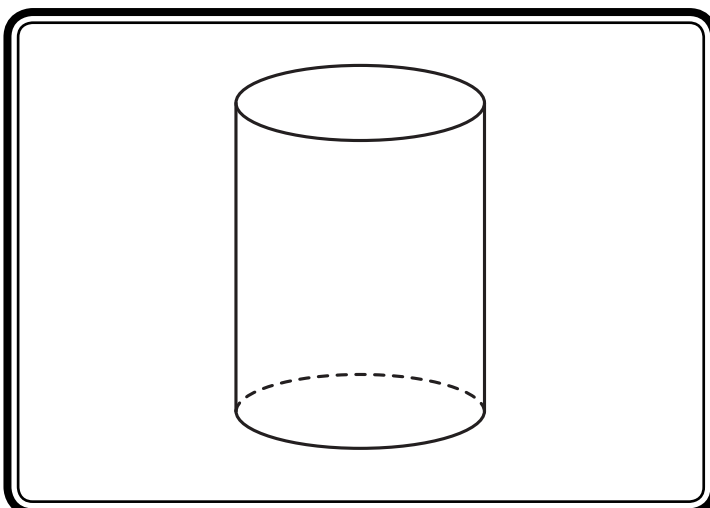
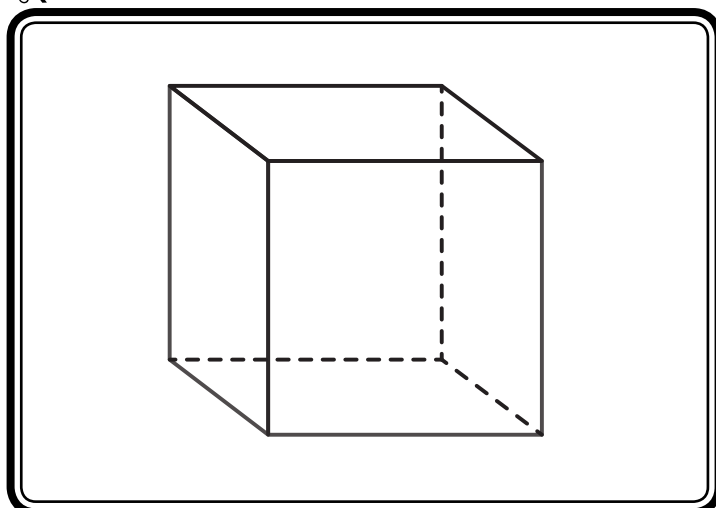

Let's Sort it!

2D Shape and 3D Object Sorting Game

CARDS



cube

cylinder

triangular
prism

square
based
pyramid

hexagonal
prism

triangular
based
pyramid

Let's Sort it!

2D Shape and 3D Object Sorting Game

CARDS

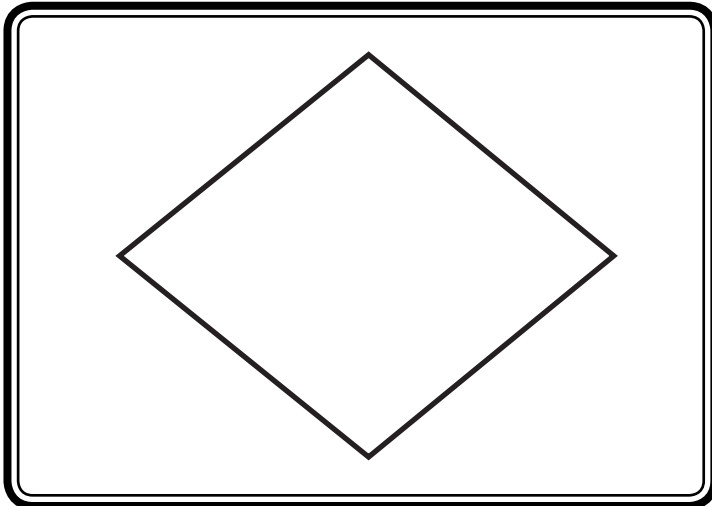
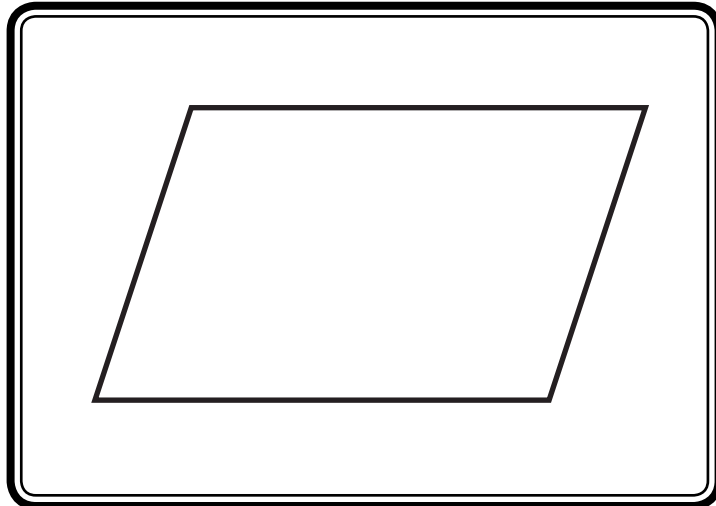
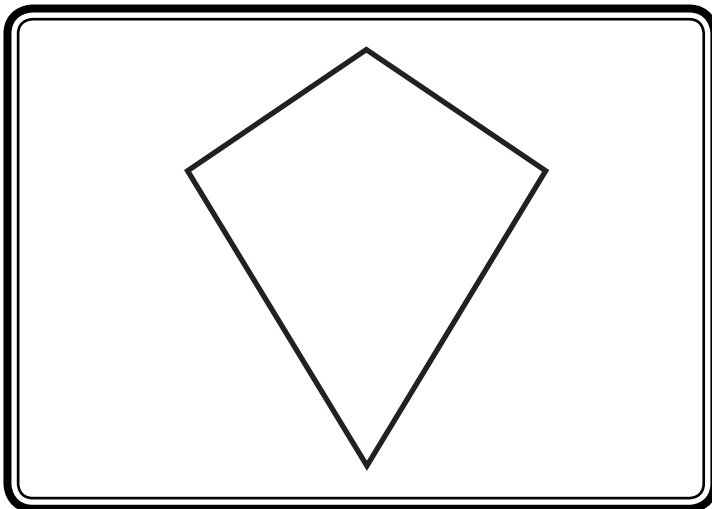
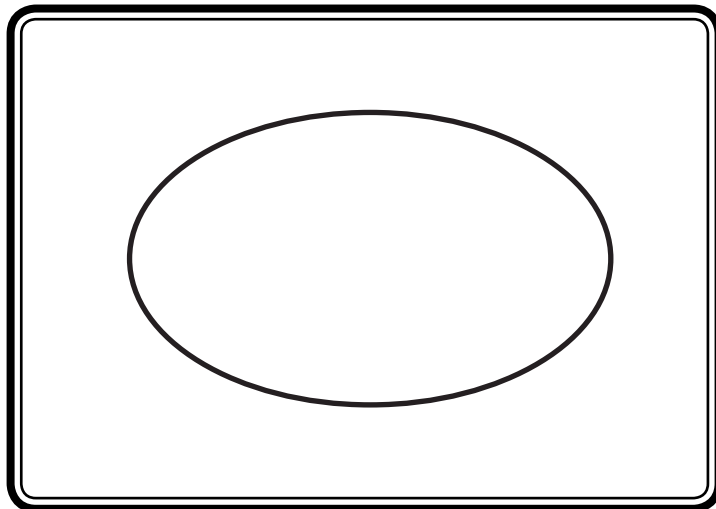
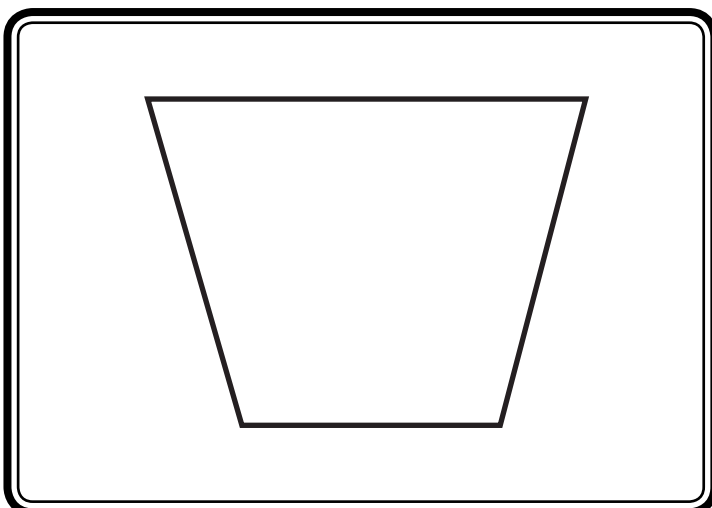
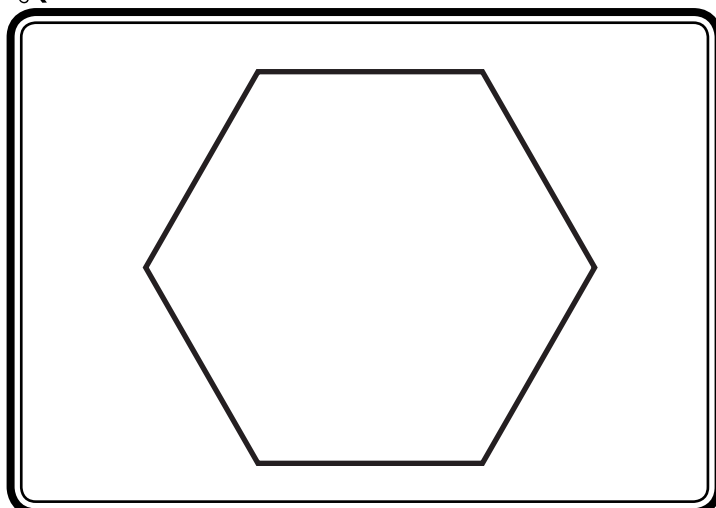

Let's Sort it!

2D Shape and 3D Object Sorting Game

CARDS



hexagon

trapezium

oval

kite

parallelogram

rhombus

Let's Sort it!

2D Shape and 3D Object Sorting Game

CARDS

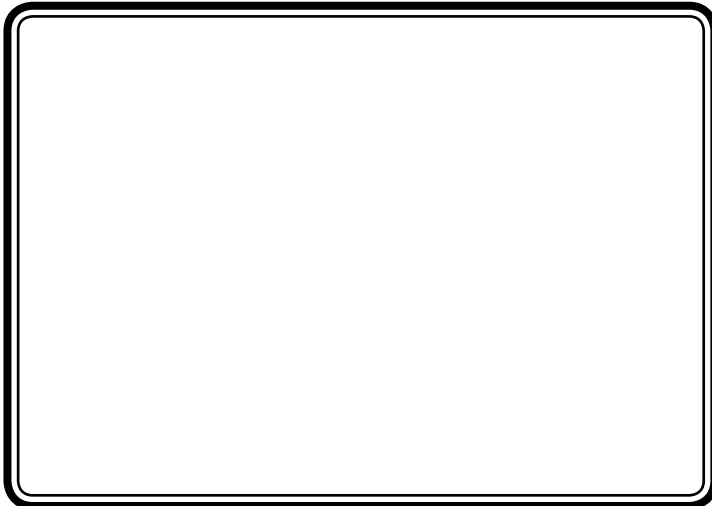
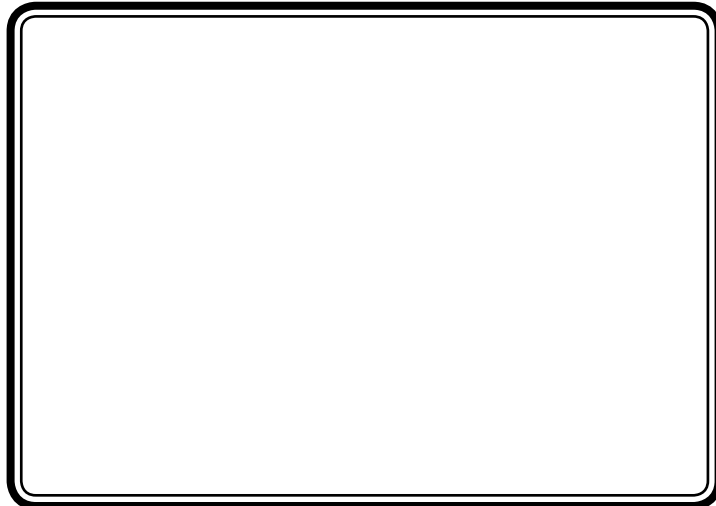
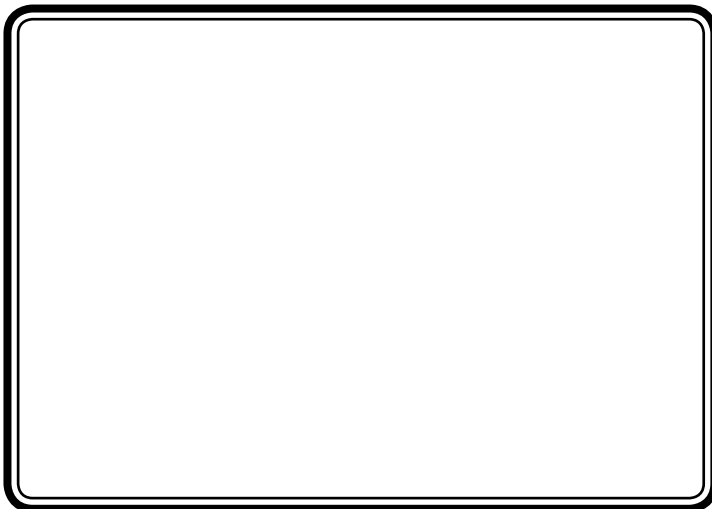
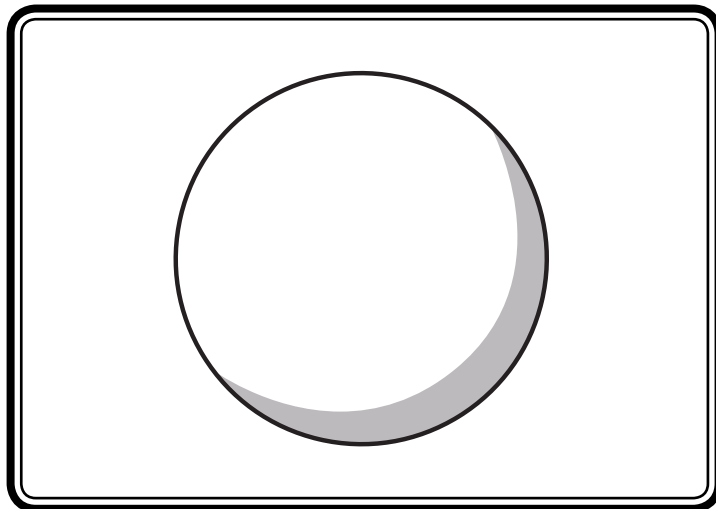
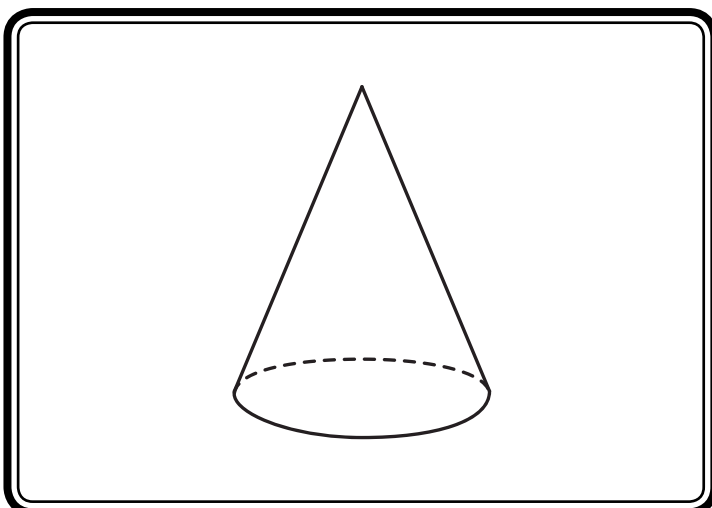
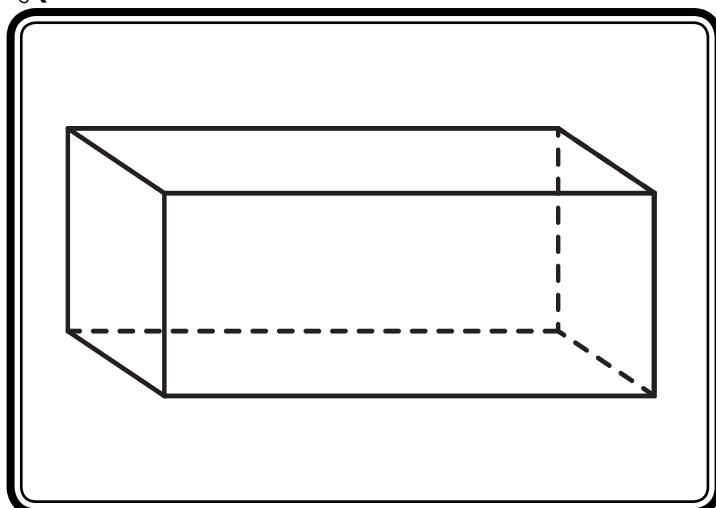

Let's Sort it!

2D Shape and 3D Object Sorting Game

CARDS



rectangular
prism

cone

sphere